

The KLP bolt interlock is a key operated mechanical bolt interlock complete with position monitoring electrical contacts for the control of electrical switchgear or valves. The KLP lock comes with a 16 mm diameter bolt of variable length, that is used to control the rotation or movement of operating handles or toggles. The KLP1 comes with 2N/C 1N/O 10 amp contacts and the KLP2 has 4N/C 2N/O 10 amp contacts, these are used to provide remote indication of the bolt position or to switch the control circuitry on the machine. The locks are manufactured in brass or stainless steel.

OPERATION

The Castell KLP bolt interlocks with safety switches are used in switchgear control to break circuitry and inhibit movement of cams, toggles or levers simultaneously.

KLP multi key bolt interlock with safety switch, rear entry, exchange key condition

- 1** Key A is free, while key B is trapped and bolt is retracted.



While the side bolt is retracted, key B is trapped and key A is free.

- 2** Insert and turn key A to extend the bolt. Release key B to trap key and change the contacts condition of the switch.

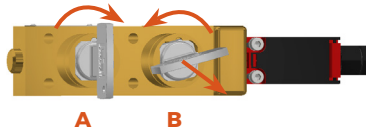

Inserting and turning key A in the KLP bolt interlock drives the bolt to extended position and allows to turn and release key B. This changes the contacts condition in the KLP switch. The extended bolt locks the power disconnector in the OFF position. Key B can now be taken by personnel into machine area.

- 3** Key B is free, key A is trapped and bolt is extended. Switch contacts are reversed.

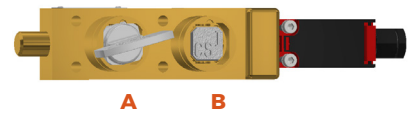

With key B released and key A trapped in the KLP, the bolt stays extended, ensuring the disconnecter is in the safe condition.

KLP multi key bolt interlock with safety switch, rear entry, double key condition

- 1** Key A and B are trapped, while the bolt is retracted.

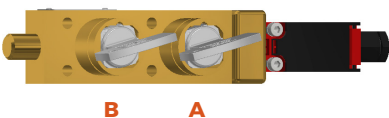

While the side bolt is retracted and key B is trapped, key A is free.

- 2** Turn and release both keys, to drive the bolt and change switch condition.

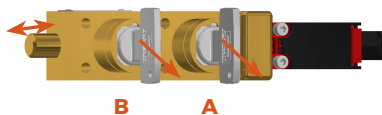

Turning and releasing key A in the KLP bolt interlock changes the contacts condition in the KLP switch and enables the rotation of key B to drive the bolt. The extended bolt locks the power disconnector in the OFF position. Both keys can now be taken by the personnel to the machine area.

- 3** Both keys are free and bolt is extended. Switch contacts are reversed.



With both keys released, the bolt stays extended, ensuring the disconnecter is in the safe condition until both keys are inserted and turned KLP bolt interlock.

USAGE

The KLP multi key bolt interlock with safety switch should be used to allow safe control of valves or disconnect switches.

 The KLP multi key bolt interlock is not designed for security purposes, such as access to a building.

INSTALLATION

The housing of the KLP bolt interlock can be mounted either to a panel or on a surface using suitable fasteners. Please refer to drawing on page 4 for more details.

 The KLP bolt interlock must be installed by a competent and qualified person who has read and understood these instructions. Please retain this document in your technical file.

 Force required to shear lock bolt is 30KN for stainless steel and 19KN for brass interlocks.

 You must use M6 anti-tamper stainless steel screws secured using threadlock set to a torque of 5 N/M.

 The manufacturer should be consulted when use in a corrosive environment is planned.

MAINTENANCE

Periodic visual checks should be carried out by the site manager / safety officer.

Do not lubricate lock barrel with oil or grease, use CK dry powder graphite if necessary.

 In case of defects being detected please contact your nearest Castell Support Department for further actions. Please see Contact section for contact details.

 The interlock must be inspected every 6 months. Safety checks should include ensuring the keys and lock bolt can only be operated in the correct safety operating conditions (see page 1).

TECHNICAL DATA

Temperature rating	-30°C ice free to +80°C
Type of mounting	Panel or surface mount using suitable fasteners (please refer to drawing on page 4 for more details)
Weight	KLP1: 1.4 kg
	KLP2: 1.6 kg
Material	Brass/Stainless steel
Switch approvals	CSA, UL, VDE
B10d	2,000,000
PL rating	PLd
Shock & vibration	EN 60068
Switch standards	IEC 60947-1 IEC 60947-5-1
Switch protection	IP65
Cable gland	M20
Switch rating	240 V, 10 amps

APPLICATION

Castell KLP bolt interlock safety component with safety switches are used as a part of an integrated safety system, typically in switchgear applications.

The electrical supply of the machine is on, and the protective doors to the hazardous area are locked. Both keys are trapped in the KLP unit. Before entering the machine area the disconnecter lever needs to be rotated to isolate the power to the machine. To lock the disconnecter lever in the safe position both keys in the KLP bolt interlock need to be released. This extends the bolt of the KLP, locks it in the extended position and changes the contacts in the KLP switch. This is connected to a traffic light or another display, indicating the access to machine area can be gained.

The removed keys are taken to the AI access interlocks to open the doors. The power supply cannot be switched back on while the keys are trapped in the access interlocks.

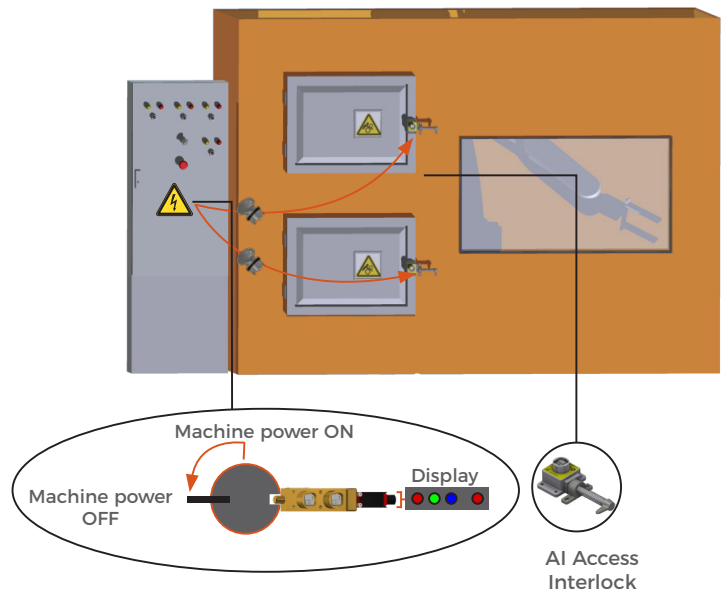

EC-DECLARATION

We, the manufacturers, declare that the components detailed herein and placed on the market comply with all the essential health and safety requirements applying to them.

ISO 13849-1:2015 Safety of Machinery

2006/42/EC Machinery Directive

Empowered signatory:

Kirstie Van Oerle
Business Unit Director



DRAWING

Dimensions: in mm

Note: For safe mounting, use security screws

KLP2, rear mounted switch

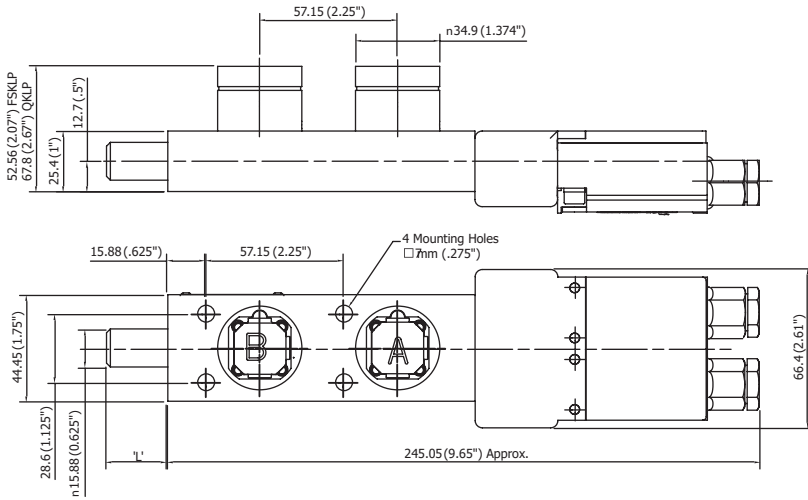

KLP1, front mounted switch

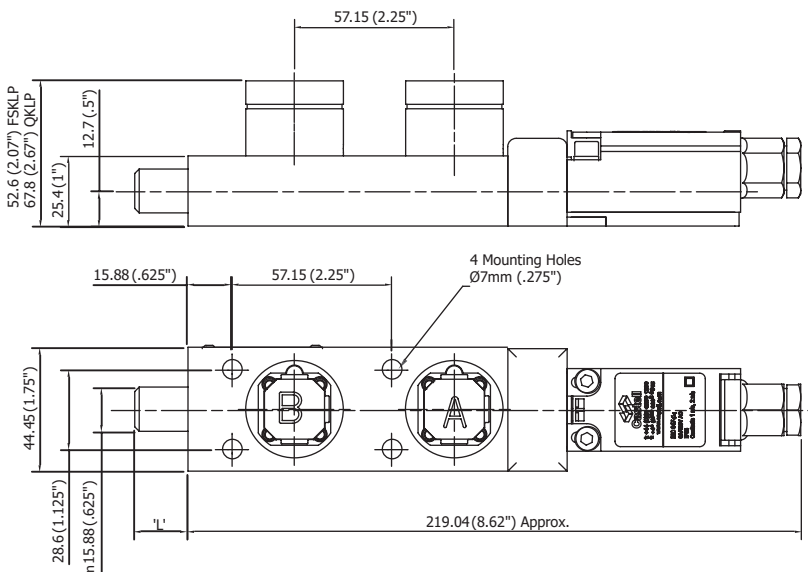

L Dimension Retracted bolt length (in mm)	Extended bolt length (in mm)
0	19.05
6.35	25.40
12.70	31.75
19.05	38.10
25.40	44.45

WIRING DIAGRAM

Bolt retracted - switch on: 2 N/C - 1 N/O

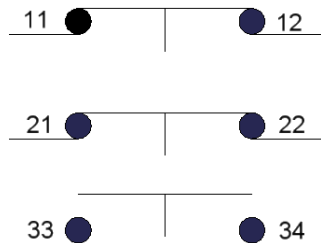

ORDER INFORMATION

	Component type	1	2	3	4	5	6	7	8
Part number	KLP								
Example	KLP	2	FS	B	1S	0	FR	4	D
	9	B	Primary key symbol		10	A	Secondary key symbol		

1	Switch specification	1 = 2NC/1NO (1 switch) ⁽²⁾ 2 = 4NC/2NO (2 switches) ⁽²⁾
2	Lock portion type	FS ⁽¹⁾ / Q ⁽¹⁾
3	Material	B = Brass / S = Stainless steel
4	Secondary lock portion(s)	1S / 2S / 3S / 4S / 5S or 6S
5	L dimension (bolt length when retracted) in mm	0 / 6.4 / 12.7 / 19.1 / 25.4
6	Switch entry	FR = Front entry switch / RE = Rear entry switch ⁽³⁾
7	Form	1 / 2 / 3 / 4 ⁽⁴⁾
8	Key condition	E = Exchange key condition / D = Double key condition (removal of all keys)
9	Lock portion symbol: Primary key	FS ⁽¹⁾ up to 3 characters / Q ⁽¹⁾ up to 6 characters
10	Lock portion symbol: Secondary key	FS ⁽¹⁾ up to 3 characters / Q ⁽¹⁾ up to 6 characters

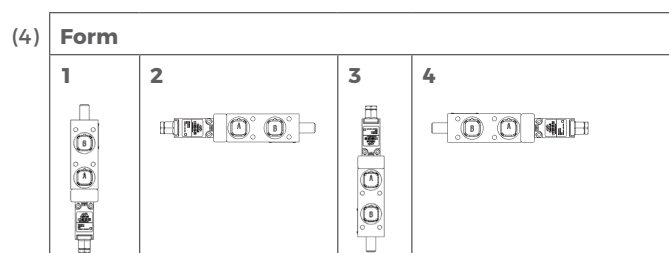
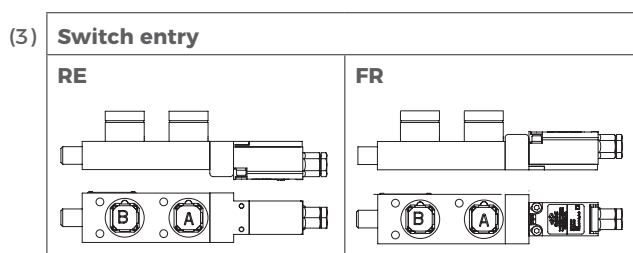
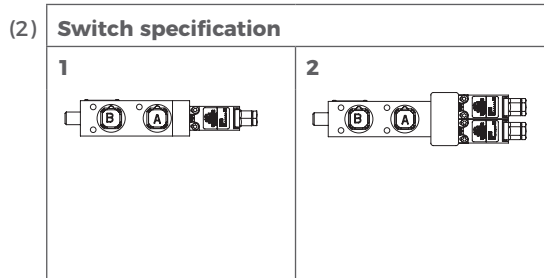
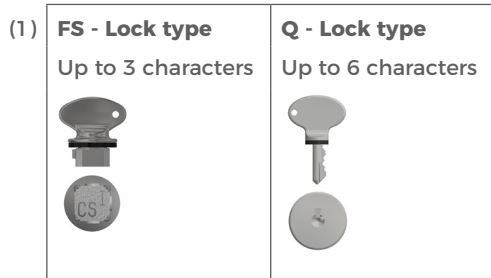

Special construction available upon enquiry

CONTACT INFORMATION

Castell Safety

The Castell Building
217 Kingsbury Road
London, NW9 9PQ
UK

t: +44 (0)20 8200 1200
f: +44 (0)20 8205 0055
e: sales@castell.com

Castell Safety

Tower 185
60185 Frankfurt am Main
Germany

t: +49 (0)69 50 50 47 310
f: +49 (0)69 50 50 47 450
e: vertrieb@castell.com

Kirk Key Interlock

9048 Meridian Circle NW
North Canton, OH 47720
USA

t: +1 800 438 2442
f: +1 330 497 4400
e: sales@kirkkey.com

SPS China

2F, Building 63
No 421 Hongcao Road, Xuhui District
Shanghai PRC, 200233
China

t: +86 (0)21 6040 7398
f: +86 (0)21 5453 0630
e: chinasales@castell.com